

WIRING DIAGRAM

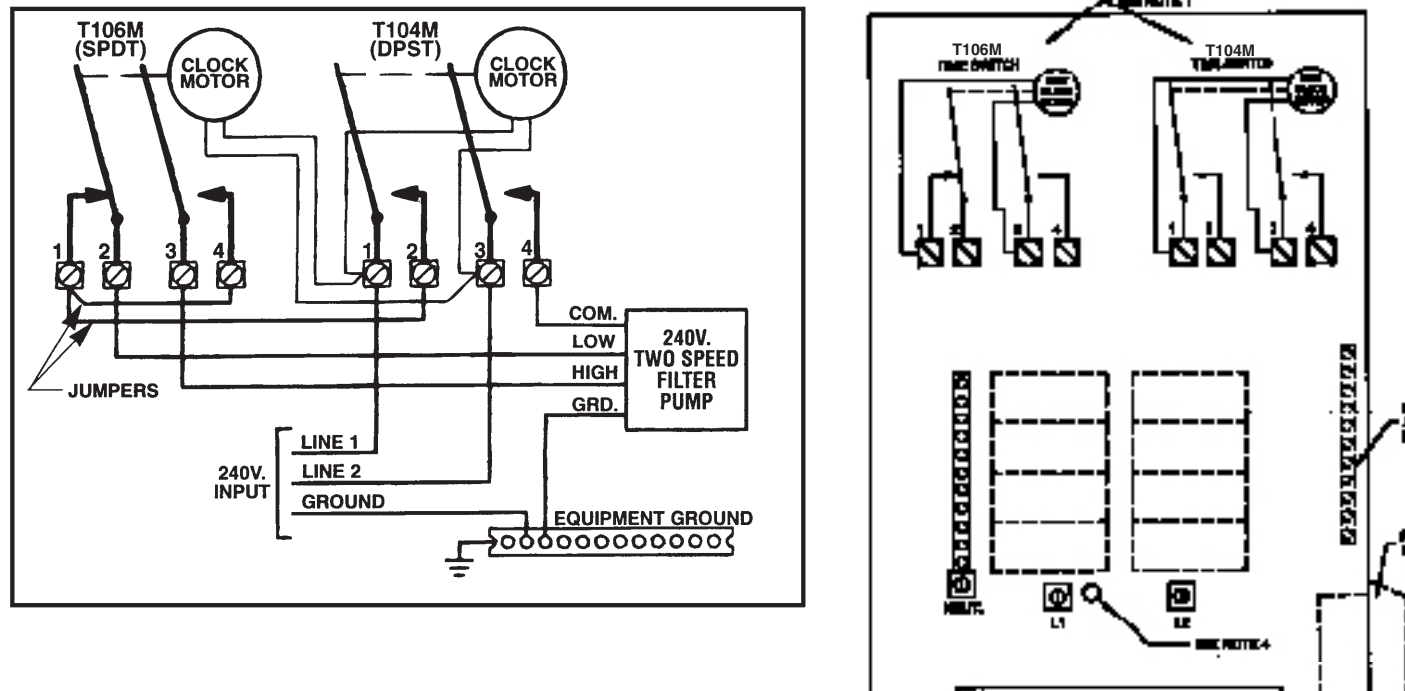

TROUBLESHOOTING

SYMPTOM	CAUSE(S)	CORRECTIVE ACTION
1. Time Switch will not keep time but dial is turning.	1a. Frequent power outages 1b. Wrong voltage/cycle 1c. Loose clock motor connections	Reset dial Change clock motor Check connections
2. Time Switch Dial stops at ON or OFF tripper.	2a. Loose tripper 2b. Bent dial 2c. Defective motor	Check/change tripper Check/change mechanism Change clock motor
3. Load is ON at all times - dial is turning.	3a. Welded contacts 3b. Two ON trippers and no OFF tripper on dial 3c. Defective mechanism	Change mechanism Change tripper Change mechanism
4. Dead clock motor. (Clock motor gears do not rotate)	4a. Defective clock motor (open coil due to lightning or surge) 4b. Loose clock motor connections 4c. Wrong voltage	Change clock motor Check connections Change clock motor
5. Filter Pump will not operate as scheduled.	5a. Time switches are out-of-sync 5b. One time switch is defective 5c. Faulty wiring 5d. Power outage	Reset time switches Replace time switch Check wiring Reset time switches

Because of our commitment to continuing research and improvements, Intermatic Incorporated reserves the right to make changes, without notice, in the specifications and material contained herein and shall not be responsible for any damages, direct or consequential, caused by reliance on the material presented.

INTERMATIC INCORPORATED, SPRING GROVE, IL 60081-9698
<http://www.intermatic.com>

158TP12267

INTERMATIC®

T30604R SERIES POOL/SPA EQUIPMENT CONTROLS

INSTALLATION OPERATION & SERVICE MANUAL

Model: T30604R

TIME CONTROL FOR TWO SPEED POOL/SPA FILTER PUMPS FOR INDOOR/OUTDOOR USE

ELECTRICAL RATING: 5 H.P. Max. - 240 Volt - 60 Hz.

Maximum running load not to exceed 28 Amperes.

Suitable for Pool Equipment Control and for Direct Conduit Connection to a Wet-Niche or No-Niche Underwater Luminaire

DANGER! TO AVOID RISK OF INJURY:

- ...do not permit children to operate the Control Unit or use the Pool/Spa unless they are closely supervised at all times.
- ...test GROUND FAULT protection regularly. If it fails to reset, DO NOT USE THE POOL or SPA!
Contact a qualified service technician.
- ...always disconnect electricity before servicing this control or the equipment connected to it. THIS CONTROL IS NOT TO BE USED AS A POWER DISCONNECT.

READ, FOLLOW AND SAVE THIS INSTRUCTION MANUAL

GENERAL INFORMATION

Many of today's energy efficient pools and spas utilize the benefits of the two stage water circulation principal. For example, while the daily cleaning process requires high pressure and fast turnover of a large amount of water in the morning, the heating, either by the sun or a heater, is more energy efficient on a slower flow rate during the day. Also, some of the new water sanitation techniques require longer dispensing time of ozone or chemicals.

The most economical way to operate a pool or spa is by the use of a two speed filter pump, together with this reliable, simple to install, simple to operate Two Speed Pump Control.

This Control is designed to automatically operate a two speed pump on a daily schedule. The all-weather enclosure contains two heavy duty, industrial grade time switches. In addition, the enclosure has a provision to install switches or a GFCI receptacle on the side as well as inside the enclosure. The time switch on the right is intended for starting and stopping the pump and the time switch on the left is for changing the speed (RPM) of the pump while it is running. The mechanism on the right can also accommodate an optional heater control (Fireman) switch.



IMPORTANT SAFETY INSTRUCTIONS

When installing and operating this electrical control and other associated equipment, basic safety precautions should always be followed, including the following:

1. Read and follow all instructions.
2. This Control must be installed by a qualified electrician, according to National and Local Electrical Codes.
3. Install this control not less than 5 feet (3 meters in Canada) from inside edge of pool. USE COPPER CONDUCTORS ONLY.
4. Do not exceed the maximum ratings of individual components, wiring devices, and current carrying capacity of conductors.
5. For grounding and bonding this Control and the installation, refer to Article 680 of the National Electrical Code.
6. The Control should not operate any equipment which would cause bodily injury or property damage should it be activated unexpectedly.

READ, FOLLOW AND SAVE THIS INSTRUCTION MANUAL

INSTALLATION

- Remove the four #10 hex head screws from the **back** of the enclosure and attach mounting brackets to enclosure.
- Select the proper location for the Control and hang enclosure on a flat vertical surface or other support, using hardware suitable for the purpose.
- Prepare the necessary conduit runs, terminate them at both ends and pull-in the conductors as specified by the installation layout.
*If this control is used for direct conduit connection to a wet niche or no niche luminaire, order one of the following: 156PA13713A for a 1/2" non-metallic kit, 156PA13714A for a 3/4" non-metallic kit, 156PA13715A for a 1" non-metallic kit, or 156PA14336A for a 1/2" metallic kit.

- Refer to Figure 1 below. Note that this enclosure contains **two** independent time switches. The one on the left is a **Model T106M**, a Single Pole Double Throw (SPDT) switch, and it's function is to **change** the speed (RPM) of the pump motor. The time switch on the right is a **Model T104M**, a Double Pole Single Throw (DPST) switch, and it's function is to **start/stop** the pump motor. To wire the two switches, follow wiring diagram on page 4 of this manual. Make sure that connections to time switch terminals are tight (25 lb. - in. minimum) and insulation clears the pressure plate - see illustration.

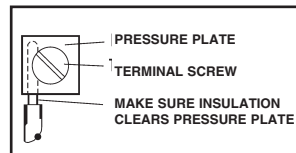

- Remove clock motor leads from **Terminals A and 3 of T106M** and connect to **Terminals 1 and 3 of T104M**. Connect **LINE 1** to **Terminal 1** and **LINE 2** to **Terminal 3 of T104M**.
- Install jumpers between **Terminals 1 and 4 of T106M** and between **Terminal 2 of T104M** and **Terminal 1 of T106M**.
- Connect **COMMON** of Two Speed Pump to **Terminal 4 of T104M**, **LOW** to **Terminal 2 of T106M** and **HIGH** to **Terminal 3 of T106M**.
- Connect green grounding conductors to the **Equipment Grounding Terminal** at bottom of enclosure.

- If required by the heater manufacturer, install fireman switch kit 156T4042A (not furnished) on Time Switch Plate and make the fireman switch connections. Use at least #18 AWG wiring with insulation rated 300 Volt or higher. Place heater ON/OFF switch on heater to **ON**.

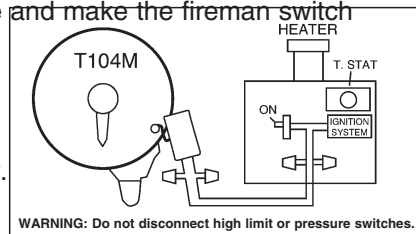

- To install additional wiring devices inside the enclosure, first remove rectangular knock-out(s) in dead front. Next, remove hex head screws in back of enclosure and install stand-offs* in place of screws. Attach wiring device to stand-offs.
 - Stand-offs are not furnished. Order 21T156A for a set of four (4) stand-offs and mounting hardware.
- If external bonding is required, install bonding lug(s) on bottom of enclosure (156T11047A may be ordered) and bond installation according to code requirements.
- Testing of the installation is optional and recommended only if pump is securely in place and will not be damaged by the following test:
 - Turn the manual level of the time switches to OFF.
 - Turn ON power at breaker panel.
 - Move the manual lever of T104M to the right (ON). Pump should start and run on **low speed**.
 - Move the manual lever of T106M to the right (ON). Pump should now be running on **high speed**.
 - Move the manual lever of T104M to the left (OFF). Pump should stop running.
 In case of unsatisfactory results, turn OFF power, check your wiring, refer to Troubleshooting on Page 4.
- Install front panel over wiring compartment. The control is now ready for programming,

Keep door closed at all times.

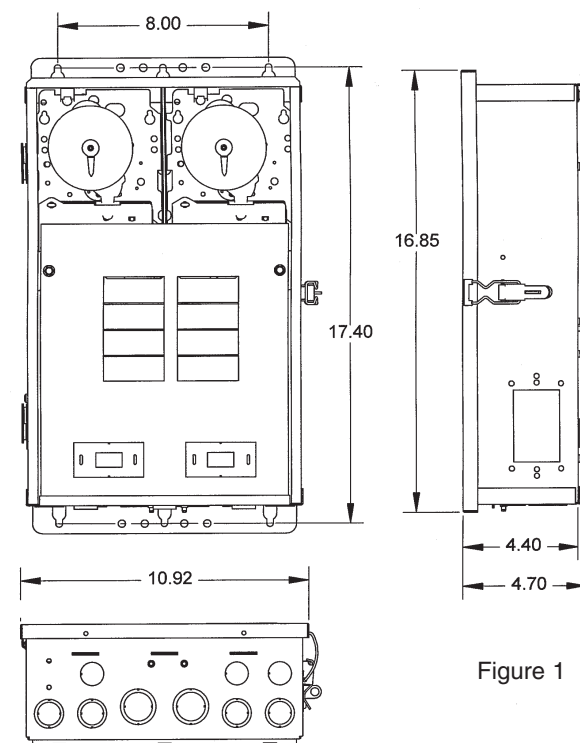

Figure 1

OPERATION

TO SET DAILY SCHEDULE: The setting of a schedule is done by placing the ON (silver) and OFF (gold) trippers on the two yellow dials. The dials turn in synchronous speed and make exactly one revolution in 24 hours. The trippers placed on the dial on the right will set the **start and stop** time of pump operation while the trippers on the left side dial will set the time the pump will **change** speed.

The length of the daily filtration/heating cycle depends on many variables such as geographic location, size and usage of pool, season of year,

type of pool equipment, etc. If not sure, contact your local pool service professional for advice.

Setting a schedule is easy:

- Set Time of Day** on both time switches by pulling out, then turning yellow dials until Time-Of-Day lines up with pointer.
- Set Start** (ON tripper) and **Stop** (OFF tripper) times on right side (T104M) dial.
- Set Low to High** (ON tripper) time and **High to Low** (OFF tripper) time on left side (T106M) dial.

EXAMPLES

The following examples are only two of the many individualized schedules one can devise.

SCHEDULE EXAMPLE #1

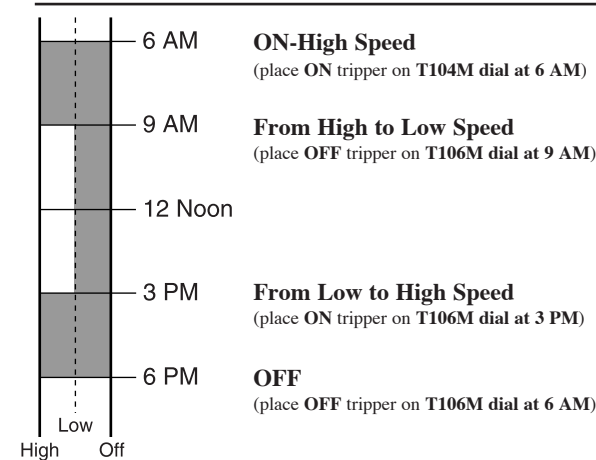

SCHEDULE EXAMPLE #2

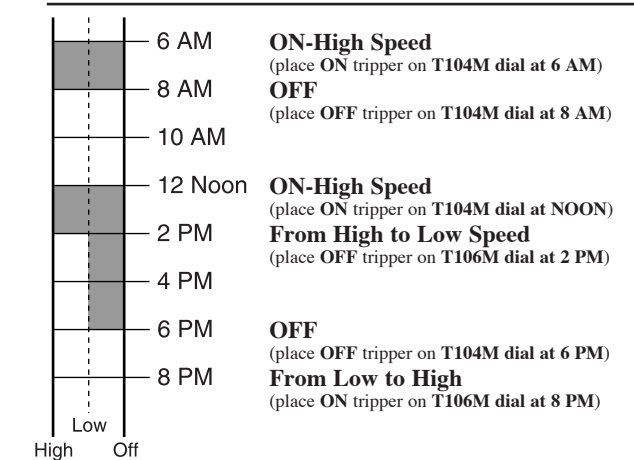

TRIPPER SETTINGS

Left Dial (T106M) Right Dial (T104M)

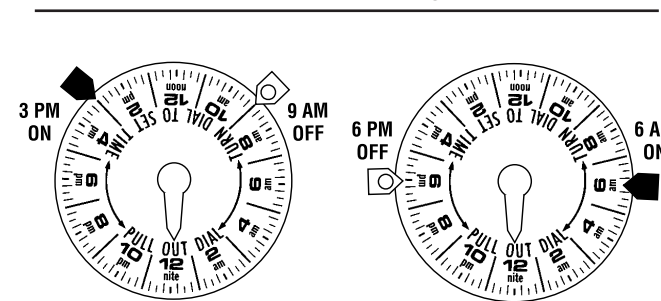

TRIPPER SETTINGS

Left Dial (T106M) Right Dial (T104M)

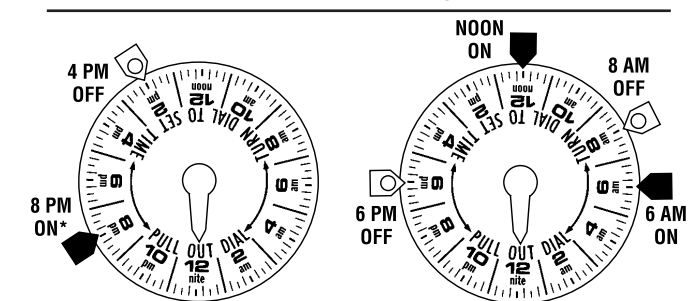

WARRANTY

If within one (1) year from the date of installation, this product fails due to a defect in material or workmanship, Intermatic Incorporated will repair or replace it free of charge.

The warranty does not cover labor for removal or reinstallation and does not apply to: (a) damage caused by accident, abuse, mishandling, or dropping; (b) a unit which has been subject to unauthorized repair; (c) units not used in accordance with directions; (d) damages exceeding the cost of the product. Some states do not allow a limitation of damages so the foregoing warranty may not apply to you. This warranty gives you specific legal rights and you may also have other rights which vary from state to state.

This warranty service is available, if the defective product or its defective component is returned with proof of purchase and date of installation, either (a) to the dealer from whom the unit was purchased or (b) by shipping prepaid to the Intermatic Service Center, Intermatic Incorporated, Intermatic Plaza, Spring Grove IL 60081-9698